

# KFi STUDIOs | Dailey Assembly

## Hardware

A M6 x 16mm (16)



B M8 x 75mm (4)



C 3/16" x 3/4" Screw (10)



D #4mm Allen Wrench (1)

E #5mm Allen Wrench (1)

## Step 1

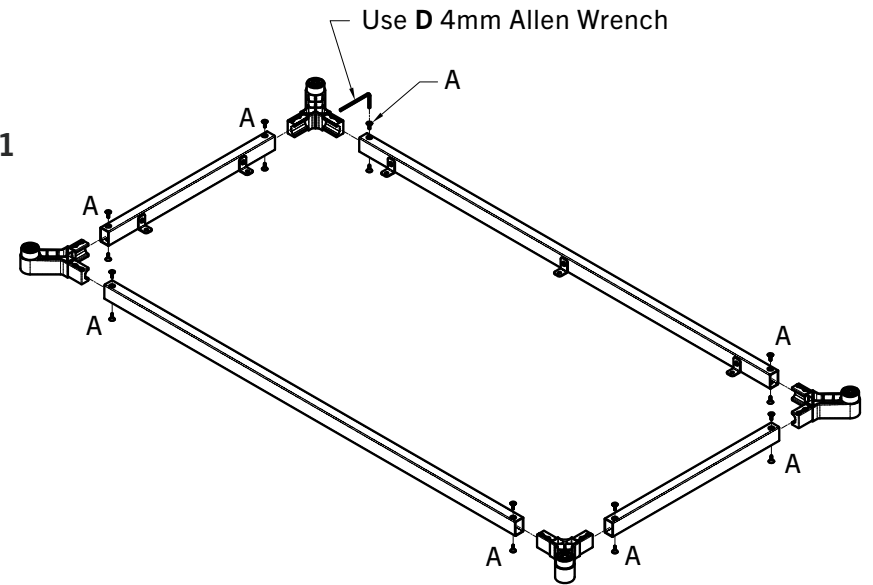

## Step 2

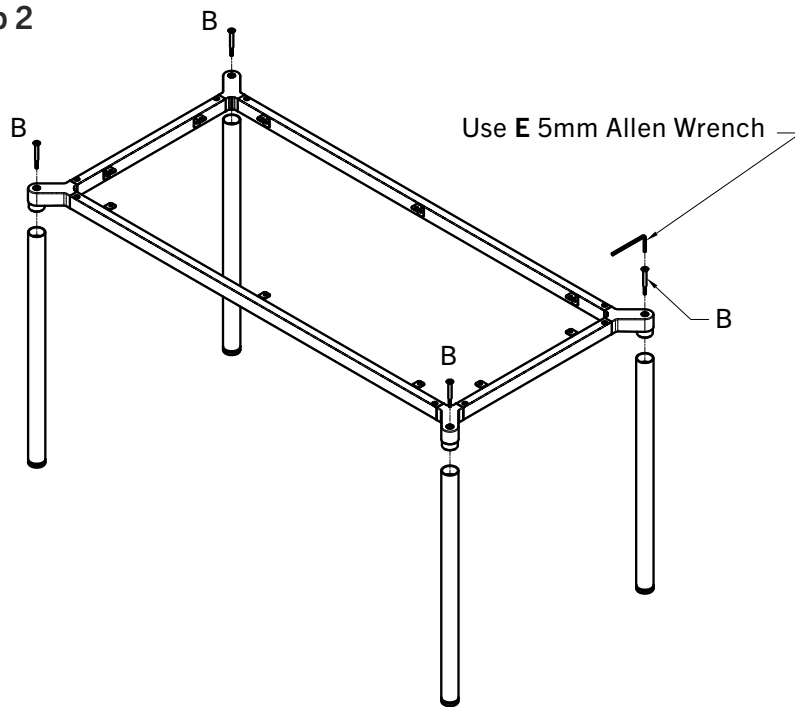

## Step 3

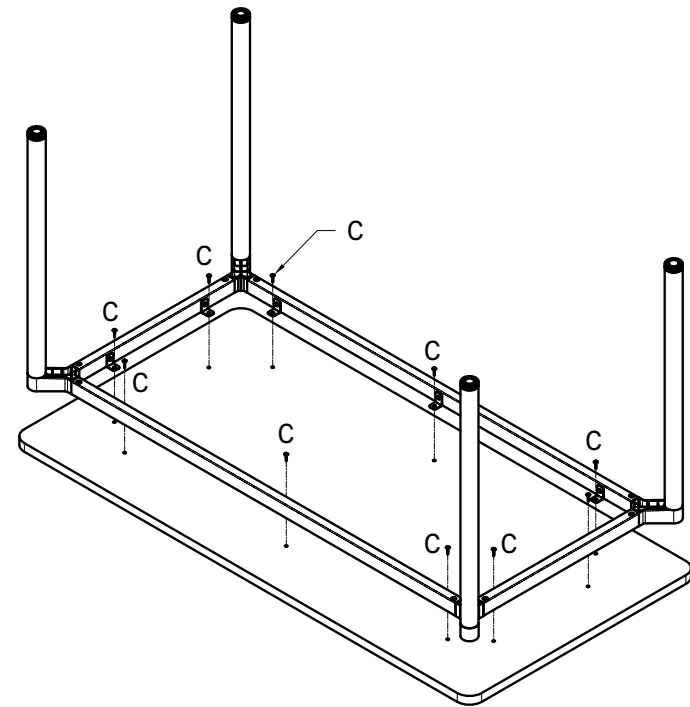

Putting together your new table is easy! Please remove all items from box and ensure all components are present.

1-800-457-5073 | [kfstudios.com](http://kfstudios.com)